

Article number: 20484M620MT
 Description: E+G T-swivel mounting
 GN 484-M6-20-MT

Measures

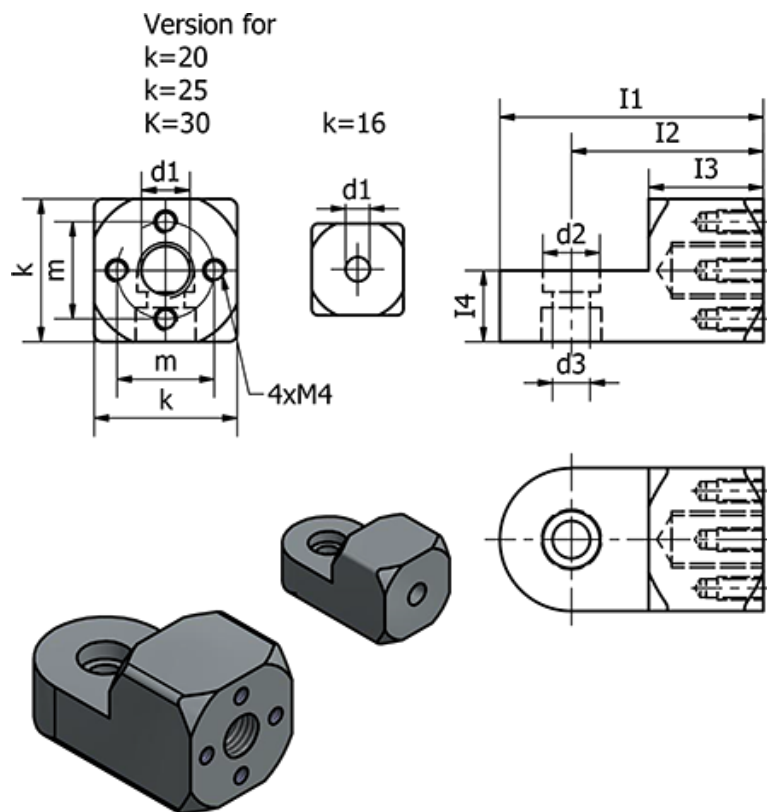

Clamping kit for d3 Type K = GN 511.1-M5-20-K

Clamping kit for d3 Type S = GN 511.1-M5-20-S

d1 = M6

d2 = 8.5

d3 = 5.5

I1 = 38

I2 = 28

I3 = 17

I4 = 10

k = 20

m = 14

Weight (g) = 24